

NR BID C

NERO Tap Range Nero Bidet Mixer with Pop-up Waste Chrome



Specification

Product Type:	Bathroom Taps
Main Construction Material:	Brass
Mount Type:	Deck
Handle Type:	Round
Connection Inlet:	1/2" BSP Flexible Tails
Connection Outlet:	Swivel-arm Flow Straightener
Number of Tap Holes:	1
Valve/Cartridge Type:	35mm Single Lever Cartridge
Plumbing System Requirements:	Suitable for all plumbing systems, ideally balanced
Minimum Dynamic Pressure (bar):	0.2 bar
Maximum Dynamic Pressure (bar):	5 bar
Maximum Hot Water Temperature °C:	65°C
Maximum Static Pressure (bar):	10 bar
Flow Type:	Single
Isolation Included:	No

Features:

- Long life ceramic cartridge for added durability and ease of use
- Metal fixing nut for added durability
- Flexible tails included
- Easy to use lever handle

Product Certifications:



For more products, visit our website:
<http://www.bristan.com>



Dimensions (measurements in mm)

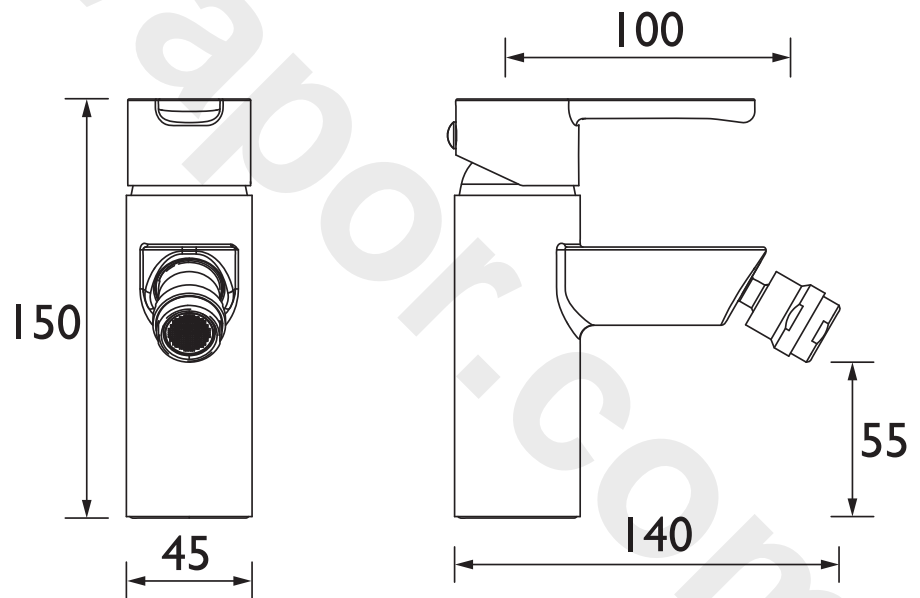

Flow Rates (l/min)

System Pressure (bar)	0.2	0.5	1	2	3	5
NR BID C (mixed)	5.2	8.3	11.7	16.6	20.3	26.2

TECHNICAL DATA SHEET



BRISTAN

D5